



Massskizze

Bei Fragen und Anregungen stehen wir Ihnen gerne zur Seite:

Faserplast AG

Sonnmattstrasse 6-8
9532 Rickenbach TG

Tel. 071 929 29 29
Mail: info@faserplast.ch
www.faserplast.ch

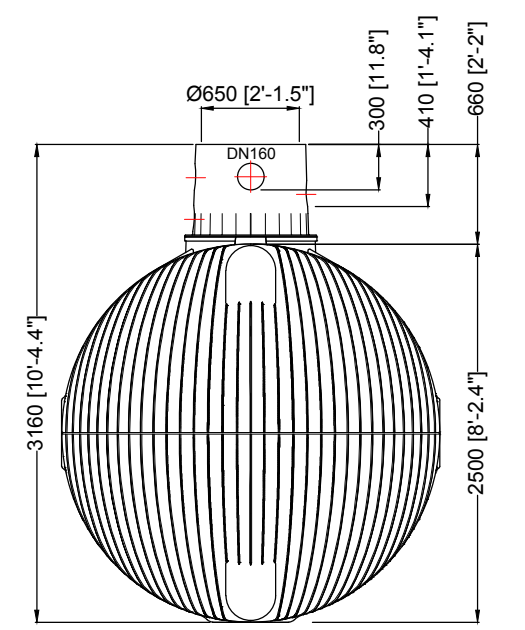
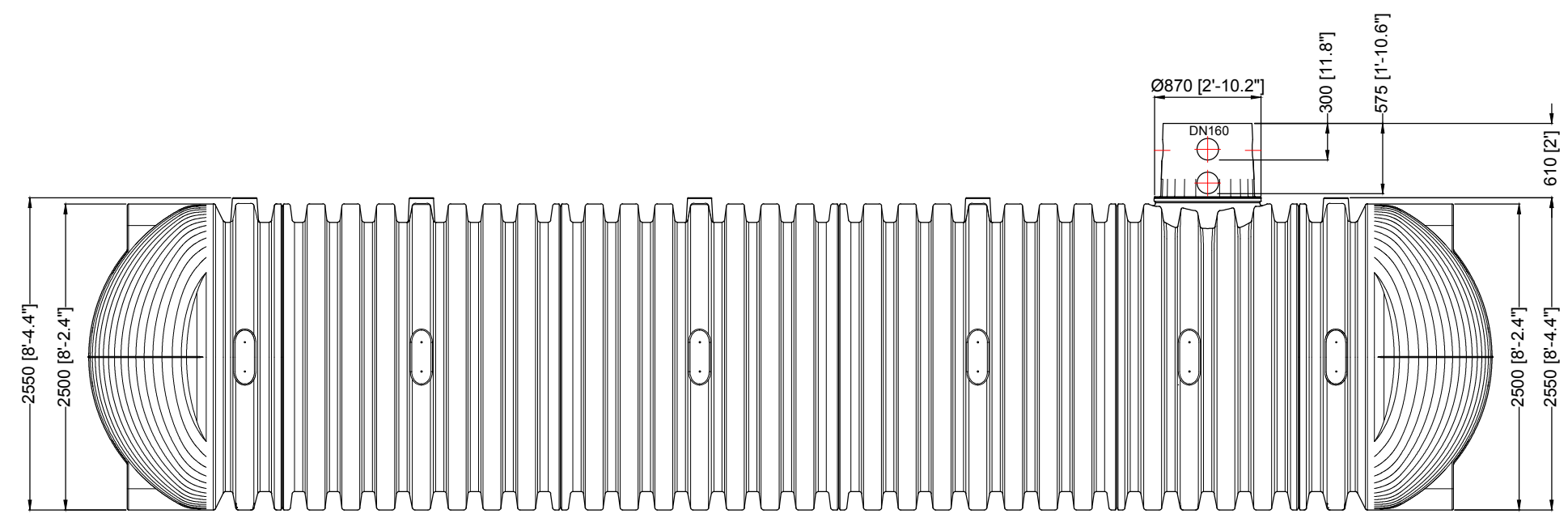
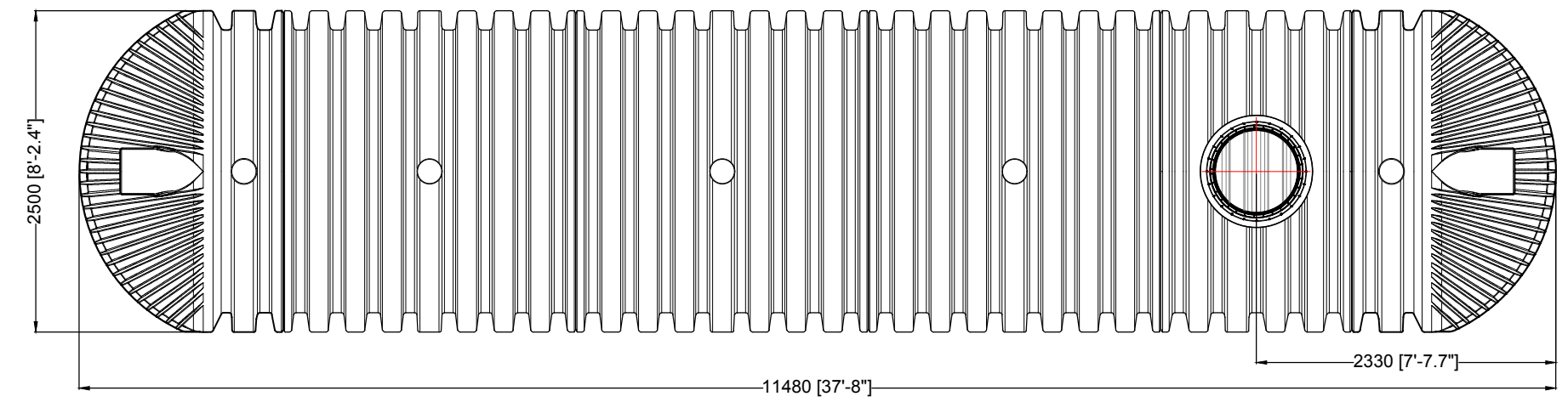

D GRAF Regenwasser-Erdtank Carat XXL 46000 L / 12151,8 gal.			Artikel-Nr. product no. article no. articulo no.	380006 (380817 / 371018)
GB GRAF underground tank Carat XXL 46000 L / 12151,8 gal.	ES GRAF Depósito soterrado Carat XXL 46000 L / 12151,8 gal.	FR GRAF Cuve à enterrer Carat XXL 46000 L / 12151,8 gal.	revision	
gezeichnet drawn	EMU	Gewicht weight	1975 kg	Otto Graf GmbH Carl-Zeiss-Str. 2-6 DE-79331 Teningen mail@graf.info www.graf.info
Datum date	2018.12.12	Toleranz tolerance	+/- 3%	
Maßstab scale	M 1:50	Einheiten units	mm [inch] gal. = US gal.	

